

Enterprise Full Touch Handheld Computer

EF551

QUICK
GUIDE



BLUEBIRD



This user manual is protected by copyright.

Copyright © 2024 Bluebird Inc. All rights reserved.

Bluebird Inc. is the designer and manufacturer of Bluebird handheld mobiles.

This manual and the programs in this device are protected under international copyright laws, and may not be copied, distributed, translated, or removed by any means.

Registered Trademark



BLUEBIRD is an emerging global brand, striving to lead the market in performance and mobility. Their products represent reliability, innovation, and innovative technology. Bluebird is a registered trademark from the global brand of Bluebird Inc. and is copyright protected.

- Bluebird and stylized Bluebird Logo are registered trademarks and symbols of Bluebird Inc.
- Qualcomm® IZat™ is a registered trademark of Qualcomm Atheros, Inc. trademark of Qualcomm Atheros, Inc.
- Adobe® is a registered trademark of Adobe Systems Inc.
- All other trademarks and copyrights are the property of their respective owners.

User's Guidance

Device type	User's guidance
Class B Device (Household Information & Communication)	This device has qualified the electromagnetic wave suitable registration and can be used as a household device at a residential area as well as any other areas.
Type Registration	This wireless device may cause propagation interference, and so, it cannot be used for life-saving services.

E-Label

Users are able to access the 'E-Label information' in no more than three steps in a device's menu.

The actual steps are : Settings > System > Regulatory labels



1.1 Symbols

This manual uses the following symbols to indicate hazards and additional information.

Symbol	Name	Description
	Warning	Indicates situations that could cause injury to yourself or others.
	Caution	Indicates situations that could cause damage to your device or other equipment.
	Note	Indicates additional information that can help you get the most out of the device.

Please read this safety precaution information carefully. Failure to follow the information provided may result in fire, electric shock, or other property damage or bodily injuries.

2. Device

- Do not press the Power button on the device if the device is wet or do not touch adapter or power cord with wet hands. There is risk of electric shock.
- Do not use your device in an explosive danger zone.
- If your device becomes wet, do not put your device in heaters, microwaves, etc. to dry it. There is a risk of explosion or malfunction.
- Do not scratch the device's touchscreen. Use only your fingers or a compatible pen. Never use an actual pen, or any other sharp object on the touchscreen.
- Although this device is very sturdy, do not drop, hit, bend, or sit on it on purpose. It can be broken.
- Do not modify, take apart, or repair the device. Contact to your customer service center. Failure to do so will void your warranty.
- Do not attempt to modify your hardware or software. It may cause device malfunction and void your warranty.
- You may not be able to use this wireless device in basements, open fields, skyscrapers, or other places where the signal is weak.
- Backup the data and information from your device. Your data, such as ringtones, texts, and voice messages, may be erased during repairs or upgrades.
- Do not paint your device. It can damage your screen or your device's exterior.
- Avoid using or storing this device at extreme temperatures. This device is designed to work at temperatures between -20°C and 50°C (-44°F and 122°F), and humidity level 95%.



1.3 Environment



- Do not use the device while driving or operating heavy machinery. Doing so may result in death or serious injury.
- Do not use the device in locations with combustible goods. Doing so may result in an explosion.



- Do not use the device in dusty or hot locations. Doing so may damage the device.
- Do not expose your device to direct sunlight such as on the dashboard of a car for extended periods of time.
- Do not use the device in humid locations. Doing so may damage the device and void the warranty.
- Do not keep the device close to air conditioner vents. Corrosion within the device may occur due to condensation from changes in temperature.
- Do not allow children to play with the device.

1.4 Charging



- Use only the approved charger. Using an incompatible charger may cause device malfunction or other damage, such as fire.
- Charge the battery at least once a year. If you keep it without charging for a long time, it may cause device malfunction.

1.5 Distraction



In some situations, using your device may distract you and cause serious injuries and damages. For example, avoid talking on the phone or texting while driving or riding a bicycle. It is strictly prohibited by law in some jurisdictions. If you cannot avoid using your device while driving, stop your vehicle or use a hand-free kit.

1.6 Frequency Interference



- This wireless device may cause radio frequency interference, so use Airplane mode or turn off the device when prohibited.
- The device emits an electromagnetic fields. It may interfere with your medical devices.
- Do not place credit cards, phone cards, bankbook, and tickets next to the device. The magnetic field of the device can damage their magnetic strips.



2.1 Package Contents

The package includes:

-EF551

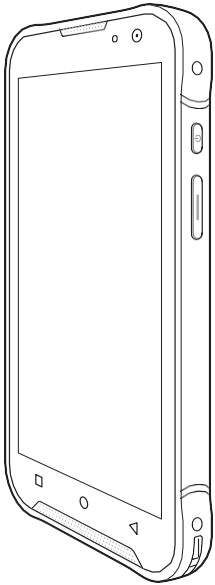

Device

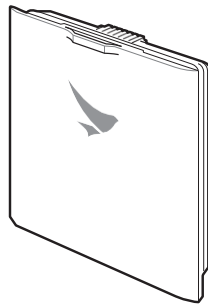

Battery



The illustrations may differ from your actual items.



2.2 Your Device

2.2.1 Front

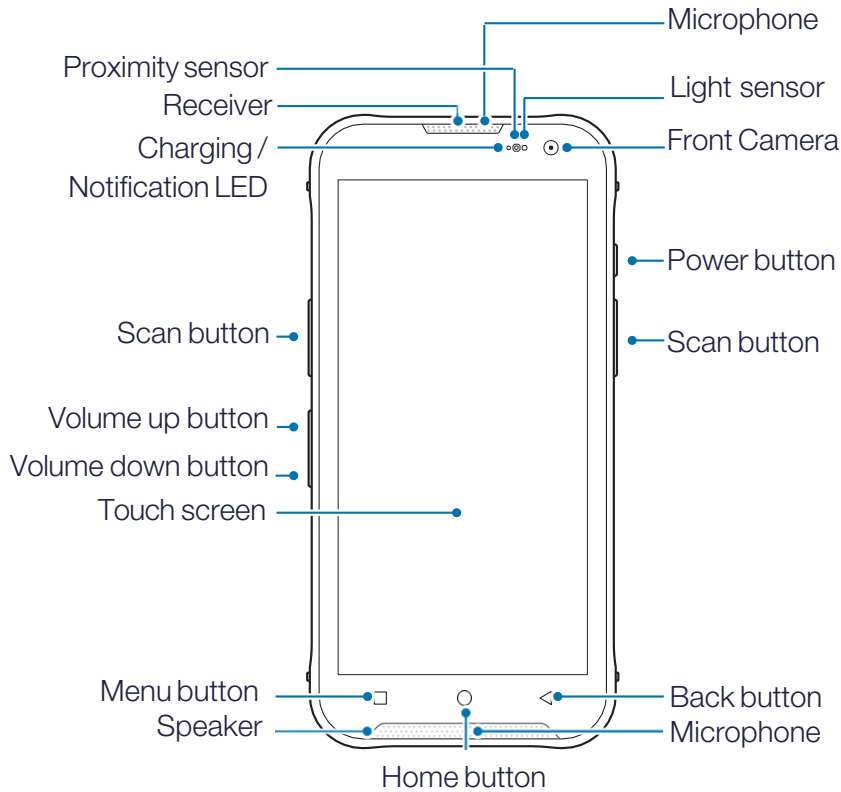

2.2.2 Back

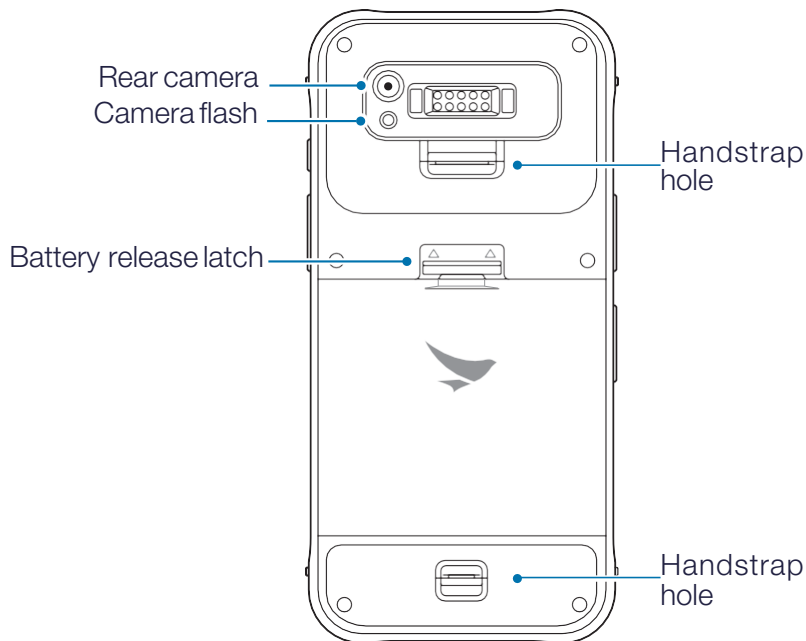



2.2.3 Bottom and Top

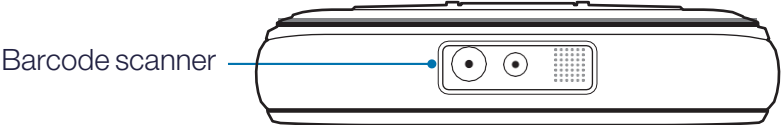
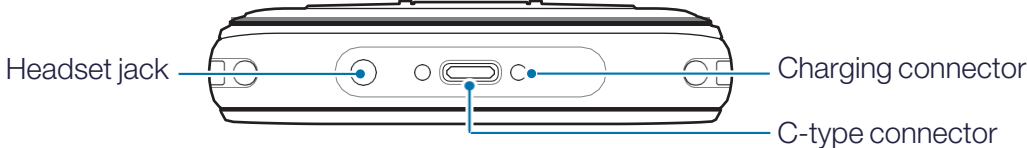



3.1 Installing the Cards

3.1.1 Inserting a Nano SIM card

1 Remove the card slot.

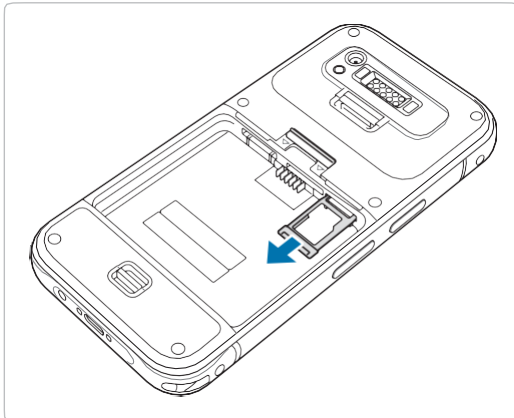

2 Insert a nano SIM cards into the slots. Make sure that the gold contacts on the cards are facing down.

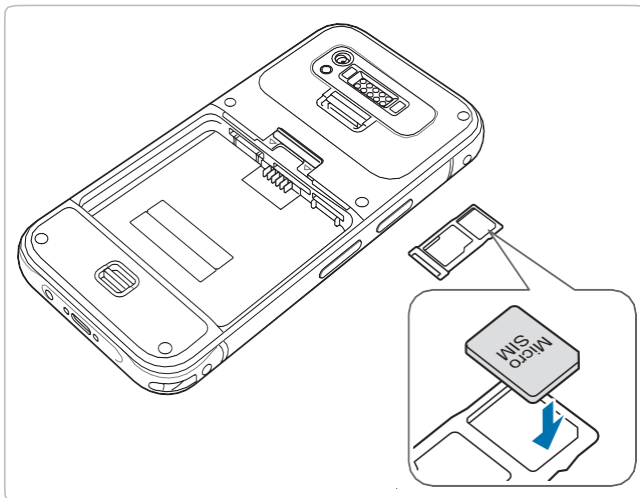

3 Insert the card slot on your device.

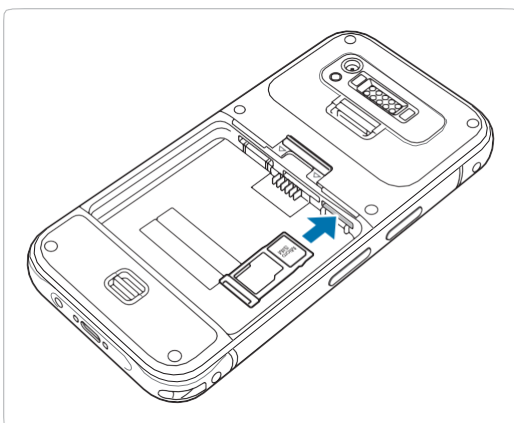



3.1.2 Inserting a Micro SD Card

1 Remove the card slot.

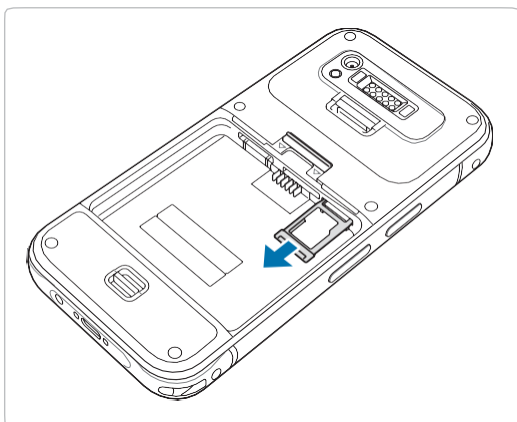

2 Insert a micro SD cards into the slots. Make sure that the gold contacts on the cards are facing down.

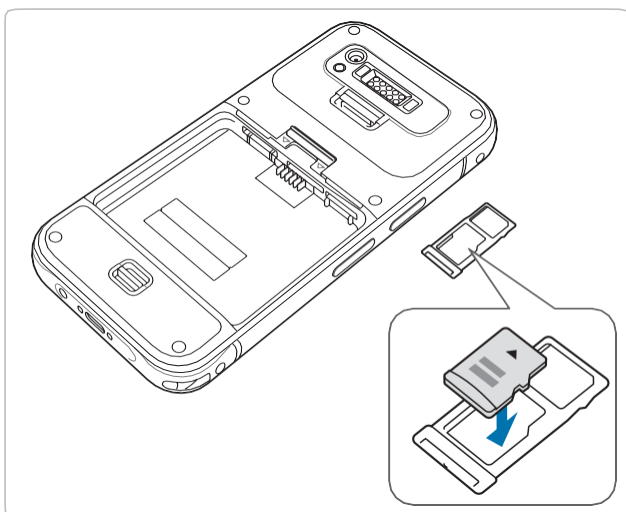

3 Insert the card slot on your device.

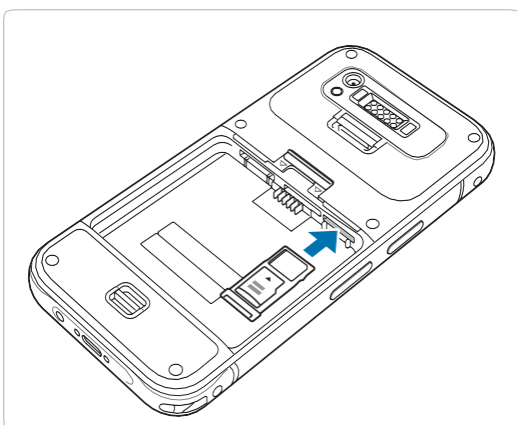

3.1.3 Removing the Cards

1 Remove the card slot .

2 Remove nano SIM or SD cards on the card slot.



3.1.4 Inserting a SAM Card

- 1 Push the SAM card toward the arrow. Make sure that the gold contacts on the cards are facing up.

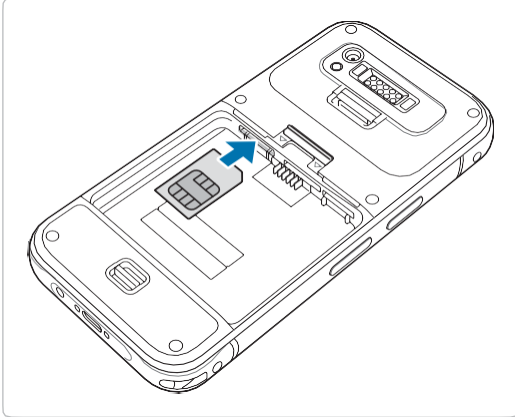

3.1.5 Removing a SAM Card

- 1 Push SAM card deeply toward inside by finger.
- 2 It will come out and take that part out.



3.2 Battery

3.2.1 Installing the Battery

1 Place the back of the device facing up.

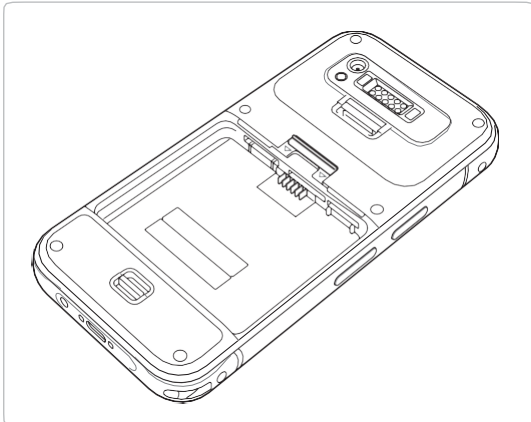

2 Insert the bottom of the battery into the device.

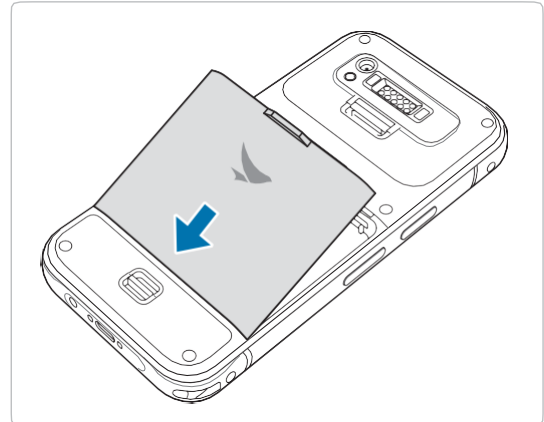

3 Press the top of the battery to fully insert the battery in the device.



4 Slide down the battery lock to lock the battery.

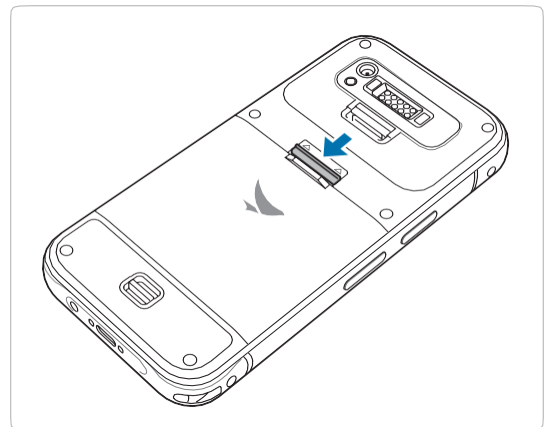



3.2.2 Removing the Battery

Slide up the battery lock to unlock the battery and pull the battery out.

! Before removing the battery, turn off the power. Failure to do so it may cause damage to the device.

3.2.3 Charging the Battery

1 Plug the C-type end of the charger into the multi-purpose jack on the bottom of the device.

- The battery charging image appears on the screen.

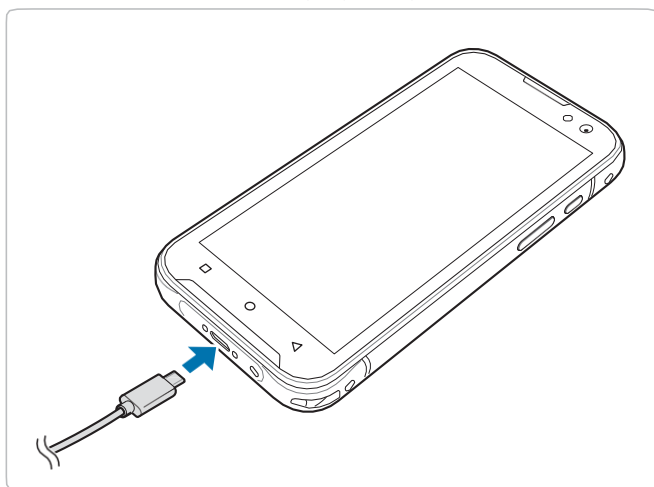

2 Connect the USB cable with power adapter and then plug the charger into a power outlet.



4.1 Turning the Device On or Off

4.1.1 Turning the Device On

Press and hold the Power button for a few seconds.

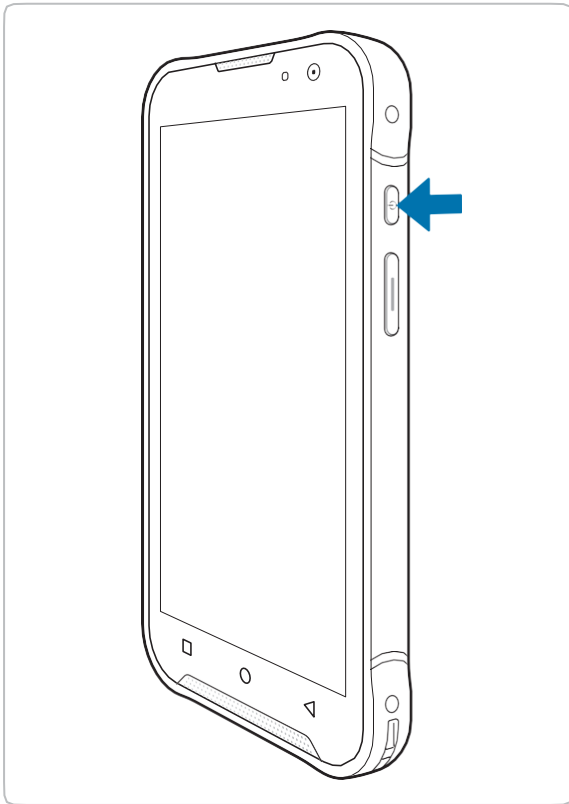

4.1.2 Turning the Device Off

1 Press and hold the Power button for a few seconds.

2 Tap **Power off**.

- To turn the screen on or off, press the Power button.
- ✔ • Registering the accounts without turning on the Wi-Fi may incur extra charges depending on your data plan.







4.2 Using the Touchscreen

Use finger gestures to use the touchscreen effectively.

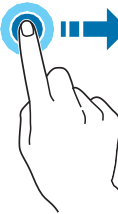

- Do not touch the screen with any sharp objects.
- Do not apply too much pressure to the touchscreen.

Gesture	Name	Description
	Tap	Briefly touch an item to open, launch, or select it.
	Zoom in or out	Place two fingers on the screen and spread them apart to zoom in. Pull the fingers together to zoom out. You can also double-tap the screen quickly to zoom in or out.
	Tap and hold	Touch an item or the screen for a few seconds to access more detailed menus or options.
	Swipe	Touch the screen and quickly flick in any direction to scroll through menus or pages.
	Drag	Touch an item or the screen for a few seconds and move your finger around the screen to move the item or move through screens.



4.3 Using the Home Screen

The Home screen is the starting point for all apps and features. It displays icons, shortcuts, and widgets for apps.

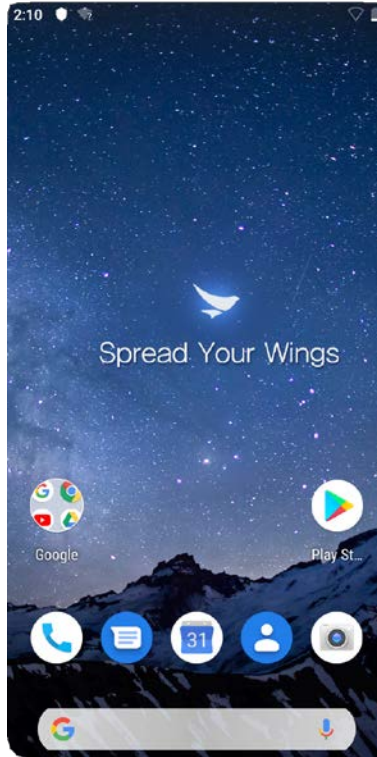

Drag upward from the bottom of the screen. Applications will be displayed on the screen. To view other pages, swipe left or right.

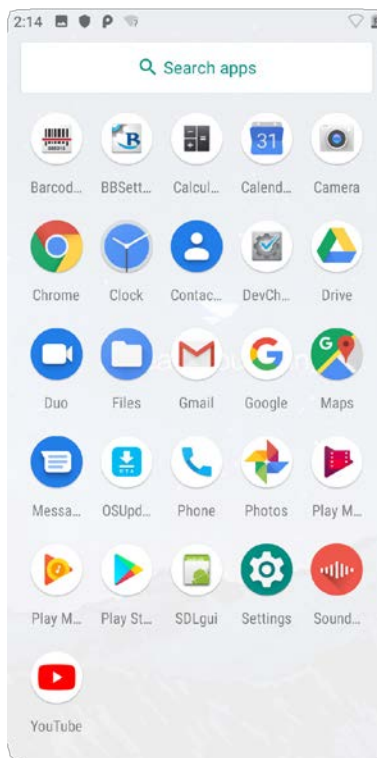



4.4 Connecting to a Wi-Fi Network

Connecting to a Wi-Fi network is an easy way of accessing the Internet. When you are out, you can connect to Wi-Fi networks in public places.

1 On the Home screen, tap  >  **Wi-Fi**.

2 Make sure to turn Wi-Fi on.

3 Tap the network you want to join.

4 If necessary, enter the password for the network and tap **CONNECT**.

To disconnect the network connection, turn Wi-Fi off.

 Your device periodically checks for and notifies you of available connections. The notification appears briefly at the top of the screen.

4.5 Connecting to a Bluetooth Device

You can connect wirelessly to various Bluetooth-compatible devices, such as phones, computers, headsets, and car kits. You can also send your photos to Bluetooth-compatible phones or to your computer.

On the Home screen, tap  >  **Bluetooth**.

Because devices with Bluetooth wireless technology communicate using radio waves, they do not need to have a direct line of sight. However, they must be within 10 meters (33 feet) of each other, although the connection may be subject to interference from obstructions, such as walls or from other electronic devices.

-  Paired devices can be connected to your device when Bluetooth turns on.
-  Other devices can detect your device only if the Bluetooth settings view is open.

 Do not accept the requests from unknown devices and also do not try to pair with an unknown devices. This helps to protect your device from harmful content.



4.6 Battery Hot Swap

-This device supports Battery Hot Swap function.

-Battery Hot Swap is a function to replace the battery with a spare battery while using the device without Power Off.

Battery hot swap operation procedure:

- 1 Turn off the LCD by pressing the power button.
- 2 After unlock the battery locker, remove the battery inside the device.
- 3 After replacing the charged battery, lock the battery locker.
- 4 To use the device, press the power button and check that the LCD is turned on.

- Before hot swap, turn off the LCD screen using the Power button.
 - The hot swap battery required for this function keeps charging while the device is turned on, and it stops when fully charged.
 - When you use the device for the first time, it is recommended to use the device after charging it in the Power On mode for at least 3 hours..
- Do not use Hot Swap within about 3 minutes after initial booting of the device.
 - After removing the battery used for Hot Swap, replace it with a fully charged spare battery within 2 minutes.
 - In case that the battery is not replaced for 10 minutes after removing the battery for Hot Swap, the device will automatically power off to prevent discharge of the hot swap battery. At this time, you need to be careful as data loss may occur.
 - Do not replace SIM, SAM, or MicroSD Card while Hot Swap is in progress.
 - Re-run at least 15 minutes later after running Battery Hot Swap.



Physical Characteristics

Dimensions (W x H x D)	159.9 x 79 x 16.65 mm
Weight	284.5g
Display	5.5" FHD+ (2160 x 1080), TFT-IPS
Imager Window	Corning Gorilla Glass
Touchpanel	Dual mode capacitive touch with stylus or bare or gloved fingertip input (conductive stylus sold separately); fingerprint resistant antismudge coating water droplet rejection;
Backlight	LED backlight
Power	User replaceable Battery 3.85V / 4,350mAh BOS™ PowerManager Station
Hot swap	Support
Expansion Slot	User Accessible MicroSD; supports up to 2TB
SIM / SAM	1 Nano SIM or 1 E-SIM 2 SAM (Optional)
Interface	USB Type C Connector (USB 3.1) Docking Connector (Charging) Rear 10-pin connector
Notification	Audible tone; multi-color LEDs; vibration
Keypad	On-screen keypad and Enterprise Keyboard; power button; volume up/down buttons' Home, Back, Menu Dual-action side scan triggers
Voice and Audio	Dual noise-cancelling microphones; vibrate alert; High-quality speaker phone; PTT headset support; Bluetooth wireless headset support, SWB & FB audio
PTT Hot Key	Support - available dual-action side scan trigger



Performance Characteristics

CPU	Qualcomm Snapdragon™ QC6490 octa-core, 2.7GHz
Operating System	Android 12; upgradeable to Android 16
Memory	4GB RAM / 64GB UFS Flash

User Environment

Operating Temp	-20°C to 50°C / -4°F to 122°F
Storage Temp	-40°C to +70°C / -40°F to +158°F
Humidity	95% non-condensing
Drop Spec	Multiple 5 ft./1.5 m to tile over concrete over -10°C to 50°C (14°F to 122°F)
Tumble Spec	1000 1.6 ft./0.5 m tumbles, meets or exceeds IEC tumble specification
Sealing	IP68 and IP65 per applicable IEC sealing specifications
Vibration	4 g's PK Sine (5 Hz to 2 kHz); 0.04g ² /Hz Random (20 Hz to 2 kHz); 60 minute duration per axis, 3 axis
Thermal Shock	-40° C to 70° C / -40° F to 158° F rapid transition 10 cycles (1 cycle = 1.25 hours at -40°C and 1.25 hours at 70°C)
Electrostatic Discharge (ESD)	+/-15kVdc air discharge +/-8kVdc direct discharge +/-8kVdc indirect discharge



Communication Options

WWAN Radio	GSM/GPRS/EDGE/WCDMA/HSDPA/HSUPA/HSPA+LTE
WLAN Radio	WiFi: IEEE 802.11 a/b/g/n/ac/d/h/i/r/k/v/w/mc/ax; 2x2 MU-MIMO : Wifi™ 6E (801.11ax) Wi-Fi™ certified; Wi-Fi™ 6E certified; IPv4, IPv6
WLAN Data Rates	6GHz: 80211a/n/ac/ax (WIFI 6E) - up to 2400 Mbps 5GHz: 802.11a/n/ac/ax — up to 1201 Mbps 2.4GHz: 802.11b/g/n/ax — up to 286.8 Mbps
WPAN Radio	Bluetooth V5.2 BLE
WCDMA	1922.8 MHz ~ 1977.2 MHz
LTE	BAND 1 : 1920 MHz ~ 1980 MHz BAND 3 : 1715 MHz ~ 1785 MHz BAND 5 : 824 MHz ~ 849 MHz BAND 7 : 2500 MHz ~ 2550 MHz BAND 8 : 904.3 MHz ~ 915.0 MHz
WLAN	5GHz: 5180 MHz ~ 5320 MHz , 5500 MHz ~ 5825 MHz 2.4GHz: 2412 MHz ~ 2472 MHz
BT & BLE	2402 MHz ~ 2480 MHz
NFC	13.56 MHz

Accessories

Accessories	'1 or 4 slot charging cradle (Includes a bay for Spare Battery Charging.) 1 or 4 slot ethernet cradle (Includes a bay for Spare Battery Charging.) 4 ~ 6 Slot Battery Charger Handstarp & Stylus Holder / Stylus Soft Holder Protective Flim Trigger Handle UHF RFID Reader Sled (w/ RFR90x)
-------------	-------------------------------------------------------------------------------------------------------------------------------------------------------------------------------------------------------------------------------------------------------------------------------------------------------------------------



위에 나열되지 않은 사양이나 향후 업그레이드 가능한 사양에 대해서는 영업 담당자에게 문의하세요.



The battery does not charge properly.

- Ensure that your device and the charging cable are connected and the charging LED is functioning correctly.
- If the battery does not charge completely, it may be dead or defective. Contact our service center. (The warranty period for battery replacement is six months.)

The battery life got shorter.

When you use network data or peripheral device such as wireless LAN or Bluetooth that require more power, your device may use more battery than usual. If it happens for an extended period of time, your battery may be dead. Then replace it with a new battery.

I dropped the device in the water.

Turn off the device. Place the device in a dry place. Let it dry completely for a considerable period of time, and then turn the device back on. If it does not turn back on, contact our service center.

My device gets too hot to touch.

It is normal for the device to warm up while it is receiving a poor signal, performing an intense workload, or charging. It should cool down if you stop using the device for a certain amount of time. If the problem continues, contact the manufacturer. It may result in a burst battery or fire.

How do I get the repair service?

You can contact your local sales representative or you can send the device via a delivery service to Bluebird's Korean headquarters. When sending the package, make sure you pay for the shipping fee in advance. When the repair is finished, Bluebird will cover the shipping cost.



Customer support

Before asking for after-sales service, please back up the data on the device. We do not back up data from the products sent to the Customer Service Center. Therefore, we assume no responsibility for loss/deletion of data.

Customer Service Center

#1103, Gplus Kolon Digital Tower 11F,
Digital-ro 26-gil 123, Guro-gu, Seoul, Republic of Korea(08390)

- Fax: +82-2-6499-2242
- Email: rma@bluebirdcorp.com
- Hours: 9:30 a.m. - 6:30 p.m. (GMT Time: +9 Hours)



The center is closed on Saturdays, Sundays, and Korean national holidays.

Registering for After-Sales Service

- We receive the products for our after-sales service through mail, delivery services and hand delivery only in principle.
- If you bought the product from a party other than Bluebird or an authorized Bluebird reseller, you need to register the product before using our after-sales service.
- Please enclose an evidence of purchase or the product receipt for our after-sales service.
- Please enclose your name, telephone number, address and details of the problem for a prompt service.
- You can ask for our after-sales service by contacting your authorized Bluebird dealer or the Customer Service Center in the head office.
- Do not intentionally damage the label on the product.
- A damaged label may result in a disadvantage to the customer.
- When you return the product to Bluebird for service, please put the product in a protective box.
- The warranty will not cover any damage which occurs during delivery. We advise you to use the box and protective cover supplied with the product.
- Make sure to deliver the product in a safe way. Bluebird assumes no responsibility for the loss of the product during delivery.



Charged services

- In the following cases, it will be charged when requesting for after-sales service.
 - Service request due to inappropriate use of the device by the customer
 - Loss of PIN number
 - Use of programs that might affect the program (over-clock, forceful changes in the input of the system, personal developments)
- Faults caused by the customer.
 - Defect due to inappropriate or careless use of the product (dropping, submersion under water, shock, damage, unreasonable operations, etc.)
 - Defect due to a repair or unauthorized technician
 - Defect caused intentionally or by the carelessness of the customer
 - Defect due to the use of fraudulent parts or components
- Other cases
 - Defect due to nature (damage caused by fire, wind, flooding, etc.)
 - Accessories are out of warranty (accessories like battery/charger/cable/adapter, etc. have a warranty of 6 months)
- Regulations for repairs after charged services
 - If the same fault occurs in the part that has been repaired within a 1 month (30 days), the part will be repaired free of charge.



No refunds will be offered in the following situations:

- The product seal has been removed (if applicable).
- The product has been damaged due to careless use by the customer or due to a natural disaster (floods, rain, fire, etc.).
- Loss of product or other components (manual, connecting cables, etc).
- DOA (Dead on Arrival) policy
If your product is DOA (Dead on Arrival), or has malfunction within 30 days of purchase (DOA period), the product will either be exchanged or provided with after-sales service.



Warranty certificate

Thank you for purchasing a product from Bluebird Inc.

- In case of accessories such as batteries, only those that match the sales list managed by the Customer Service Center will be eligible for customer service.
- A repair or an exchange of batteries that does not match the sales list of the Customer Service Center due to the carelessness of the customer will be fully charged.

Name of Product	Enterprise Full Touch Handheld Computer
Name of Model	EF551
Date of Purchase	
Manufacture Number	
Place of Purchase	
Term of Guarantee	1 year from purchase

Warranty information

- Bluebird Inc. (hereinafter referred to as Bluebird) provides the warranty service for its products in compliance with the Bluebird's warranty program.
- Upon receiving a notification on a defect of its product within the range of warranty during the warranty period, Bluebird will repair or replace the defective product according to its warranty policy.
- If the defective product within the range of warranty is not repairable or replaceable, Bluebird shall refund the purchasing price within a designated period from the date of receiving a notice of defect.
- Bluebird assumes no responsibility for repairing, replacement or refund until it receives the defective product from the customer. The replacement shall be equivalent to a new product in the aspect of performance.
- Bluebird products may contain the recycled products, components or materials equivalent to new products in the aspect of performance.
- This warranty is applied to software products only when the programming commands are not executed. Bluebird does not guarantee interruption-free or error-free performance.



BLUEBIRD CUSTOMER SERVICE

Operating Hours

Monday to Friday 9:30 A.M. - 6:30 P.M.
(GMT Time: +9 Hours)

The center is closed on Saturdays,
Sundays, and Korean national holidays.

Customer Service Center

#1103, Gplus Kolon Digital Tower 11F,
Digital-ro 26-gil 123, Guro-gu, Seoul,
Republic of Korea(08390)

Bluebird constantly strives to bring utmost
satisfaction to all our customers.